

HS1103-2

HALF STAR R9,70
14x18mm, 23,80mm HIGH

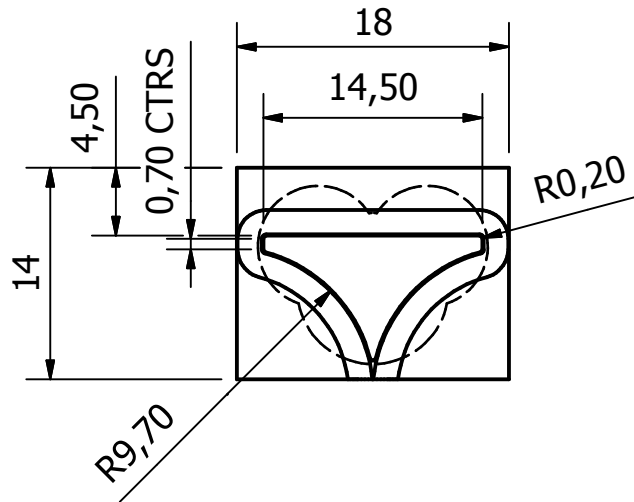

Stellar



Technik